

The copyright of these drawings and enclosures which are consigned to the addressee remains at all times in possession of simatec innovation ag. Without our written authorisation it is emphatically prohibited neither to copy or duplicate them nor is it allowed to access them to any person of a third party.

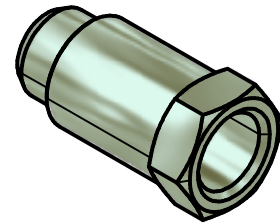
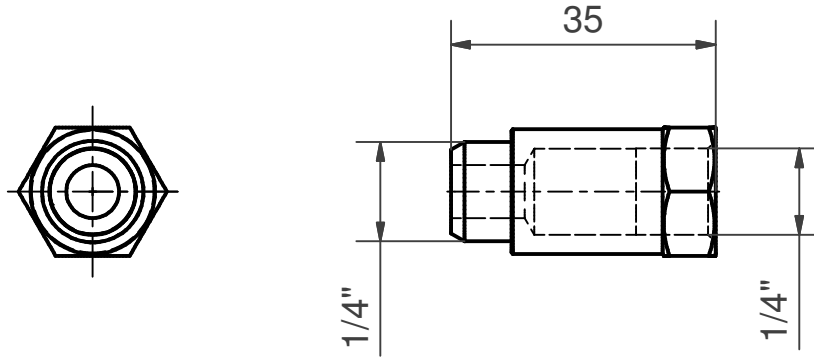

g					Ersetzt durch:		Massstab		
f								Ersatz für:	1:1
e									
d				Datum	Name				
c				Gezeichnet	04.03.2011	pz	Verlängerung L=35mm		
b				Geprüft					
a				Freigegeb.					
Index	Änderungen	Datum	Name						

simatec
smart technologies

CH-3380 Wangen a. Aare

1040

1

A4

S:\3. Leistungserbringung\3.10 Produktentwicklung\3.10.05 Produktentwicklung\CAD\Konstrukt\06 Lube\6_21 Verkaufsteile\Zeichnung\1040_Verlängerung_L_35.dwg